

MOTOROLA
SEMICONDUCTOR
 TECHNICAL DATA

Designer's Data Sheet
TMOS IV
Power Field Effect Transistors
N-Channel Enhancement-Mode Silicon Gate

This advanced "E" series of TMOS power MOSFETs is designed to withstand high energy in the avalanche and commutation modes. These new energy efficient devices also offer drain-to-source diodes with fast recovery times. Designed for low voltage, high speed switching applications in power supplies, converters and PWM motor controls, these devices are particularly well suited for bridge circuits where diode speed and commutating safe operating area are critical, and offer additional safety margin against unexpected voltage transients.

- Internal Source-to-Drain Diode Designed to Replace External Zener Transient Suppressor — Absorbs High Energy in the Avalanche Mode — Unclamped Inductive Switching (UIS) Energy Capability Specified at 100°C.
- Commutating Safe Operating Area (CSOA) Specified for Use in Half and Full Bridge Circuits
- Source-to-Drain Diode Recovery Time Comparable to a Discrete Fast Recovery Diode
- Diode is Characterized for Use in Bridge Circuits
- DC Equivalent to IRFZ40



MTM50N05E

TMOS POWER FETs
 50 AMPERES
 $R_{DS(on)} = 0.028 \text{ OHM}$
 50 VOLTS

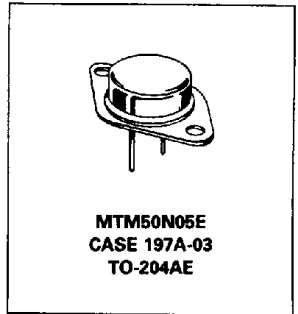
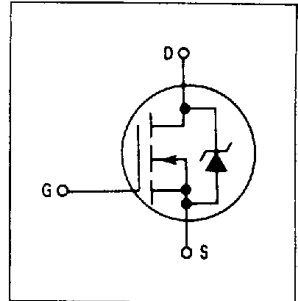

MAXIMUM RATINGS ($T_J = 25^\circ\text{C}$ unless otherwise noted)

Rating	Symbol	Value	Unit
Drain-Source Voltage	V_{DSS}	50	Vdc
Drain-Gate Voltage ($R_{GS} = 1 \text{ M}\Omega$)	V_{DGR}	50	Vdc
Gate-Source Voltage — Continuous	V_{GS}	± 20	Vdc
— Non-repetitive ($t_p \leq 50 \mu\text{s}$)	V_{GSM}	± 40	Vpk
Drain Current — Continuous ($T_C = 25^\circ\text{C}$)	I_D	50	Adc
— Pulsed	I_{DM}	160	
Total Power Dissipation @ $T_C = 25^\circ\text{C}$	P_D	125	Watts
Derate above 25°C		1	W/ $^\circ\text{C}$
Operating and Storage Temperature Range	T_J, T_{stg}	-65 to 150	$^\circ\text{C}$

THERMAL CHARACTERISTICS

Thermal Resistance			$^\circ\text{C/W}$
Junction to Case	$R_{\theta JC}$	1.0	
Junction to Ambient	$R_{\theta JA}$	30	
Maximum Lead Temperature for Soldering Purposes, 1/8" from case for 5 seconds	T_L	300	$^\circ\text{C}$

Designer's Data for "Worst Case" Conditions — The Designer's Data Sheet permits the design of most circuits entirely from the information presented SOA Limit curves — representing boundaries on device characteristics — are given to facilitate "worst case" design

3

MTM50N05E

ELECTRICAL CHARACTERISTICS ($T_C = 25^\circ\text{C}$ unless otherwise noted)

Characteristic	Symbol	Min	Max	Unit
----------------	--------	-----	-----	------

OFF CHARACTERISTICS

Drain-Source Breakdown Voltage ($V_{GS} = 0, I_D = 0.25 \text{ mA}$)	$V_{(BR)DSS}$	50	—	Vdc
Zero Gate Voltage Drain Current ($V_{DS} = \text{Rated } V_{DSS}, V_{GS} = 0$) ($V_{DS} = 0.8 \text{ Rated } V_{DSS}, V_{GS} = 0, T_J = 125^\circ\text{C}$)	I_{DSS}	— —	10 80	μA
Gate-Body Leakage Current, Forward ($V_{GSF} = 20 \text{ Vdc}, V_{DS} = 0$)	I_{GSSF}	—	100	nAdc
Gate-Body Leakage Current, Reverse ($V_{GSR} = 20 \text{ Vdc}, V_{DS} = 0$)	I_{GSSR}	—	100	nAdc

ON CHARACTERISTICS*

Gate Threshold Voltage ($V_{DS} = V_{GS}, I_D = 250 \mu\text{A}$) $T_J = 100^\circ\text{C}$	$V_{GS(th)}$	2 1.5	4 3.5	Vdc
Static Drain-Source On-Resistance ($V_{GS} = 10 \text{ Vdc}, I_D = 25 \text{ Adc}$)	$R_{DS(on)}$	—	0.028	Ohm
Drain-Source On-Voltage ($V_{GS} = 10 \text{ V}$) ($I_D = 50 \text{ Adc}$) ($I_D = 25 \text{ Adc}, T_J = 100^\circ\text{C}$)	$V_{DS(on)}$	— —	1.4 1.3	Vdc
Forward Transconductance ($V_{DS} = 15 \text{ V}, I_D = 25 \text{ A}$)	g_{FS}	17	—	mhos

DRAIN-TO-SOURCE AVALANCHE CHARACTERISTICS

Unclamped Inductive Switching Energy See Figures 14 and 15 ($I_D = 160 \text{ A}, V_{DD} = 25 \text{ V}, T_C = 25^\circ\text{C}$, Single Pulse, Non-repetitive) ($I_D = 50 \text{ A}, V_{DD} = 25 \text{ V}, T_C = 25^\circ\text{C}$, P.W. $\leq 35 \mu\text{s}$, Duty Cycle $\leq 1\%$) ($I_D = 20 \text{ A}, V_{DD} = 25 \text{ V}, T_C = 100^\circ\text{C}$, P.W. $\leq 35 \mu\text{s}$, Duty Cycle $\leq 1\%$)	WDSR	— — —	55 100 35	mJ
---	------	-------------	-----------------	----

DYNAMIC CHARACTERISTICS

Input Capacitance	$(V_{DS} = 25 \text{ V}, V_{GS} = 0,$ $f = 1 \text{ MHz})$ See Figure 16	C_{iss}	—	3000	pF
Output Capacitance		C_{oss}	—	1200	
Reverse Transfer Capacitance		C_{rss}	—	400	

SWITCHING CHARACTERISTICS* ($T_J = 100^\circ\text{C}$)

Turn-On Delay Time	$(V_{DD} = 25 \text{ V}, I_D = 0.5 \text{ Rated } I_D$ $R_{gen} = 4.7 \text{ ohms})$ See Figure 9	$t_{d(on)}$	—	25	ns
Rise Time		t_r	—	60	
Turn-Off Delay Time		$t_{d(off)}$	—	70	
Fall Time		t_f	—	25	
Total Gate Charge	$(V_{DS} = 0.8 \text{ Rated } V_{DSS},$ $I_D = \text{Rated } I_D, V_{GS} = 10 \text{ V})$ See Figures 17 and 18	Q_g	55 (Typ)	60	nC
Gate-Source Charge		Q_{gs}	30 (Typ)	—	
Gate-Drain Charge		Q_{gd}	25 (Typ)	—	

SOURCE DRAIN DIODE CHARACTERISTICS*

Forward On-Voltage	$(I_{SD} = 51 \text{ A}, V_{GS} = 0,$ $di/dt = 100 \text{ A}/\mu\text{s})$	V_{SD}	1.9 (Typ)	2.5	Vdc
Forward Turn-On Time		t_{on}	Limited by stray inductance		
Reverse Recovery Time		t_{rr}	(Typ)	250	ns

INTERNAL PACKAGE INDUCTANCE (TO-204)

Internal Drain Inductance (Measured from the contact screw on the header closer to the source pin and the center of the die)	L_d	5 (Typ)	—	nH
Internal Source Inductance (Measured from the source pin, 0.25" from the package to the source bond pad)	L_s	12.5 (Typ)	—	

*Pulse Test Pulse Width $\leq 300 \mu\text{s}$, Duty Cycle $\leq 2\%$

TYPICAL ELECTRICAL CHARACTERISTICS

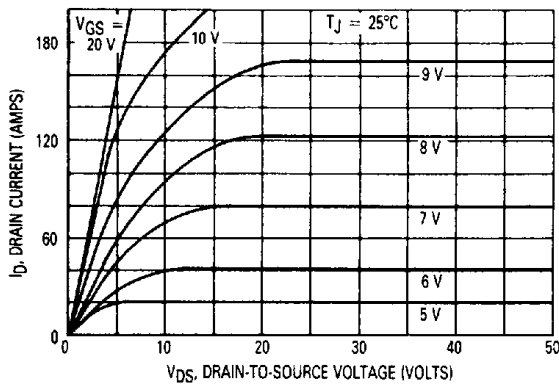

Figure 1. On-Region Characteristics

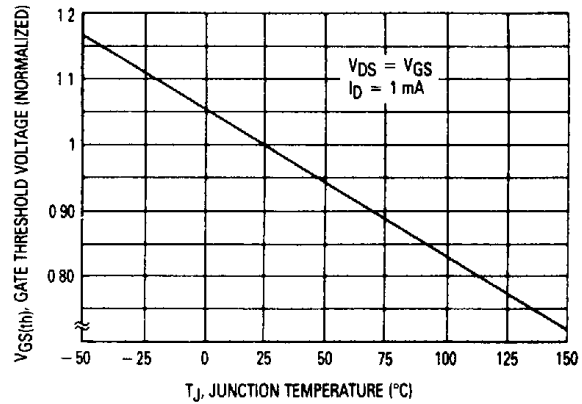

Figure 2. Gate-Threshold Voltage Variation With Temperature

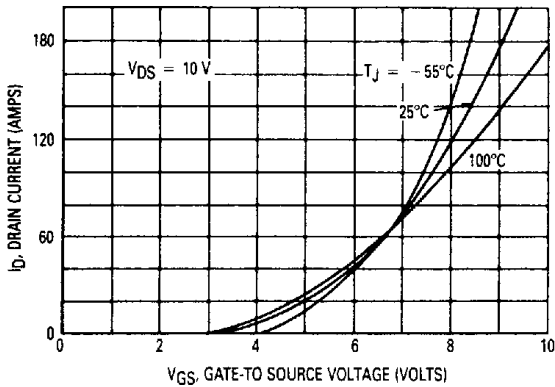

Figure 3. Transfer Characteristics

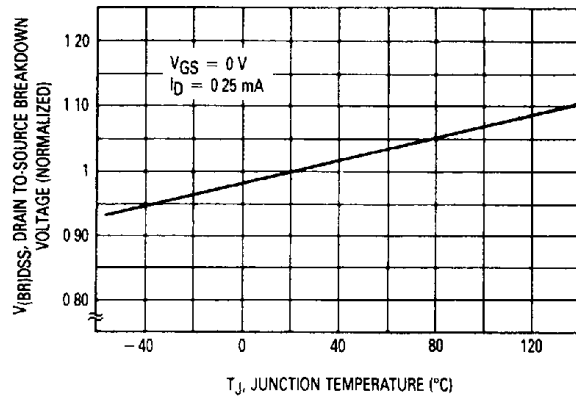

Figure 4. Breakdown Voltage Variation With Temperature

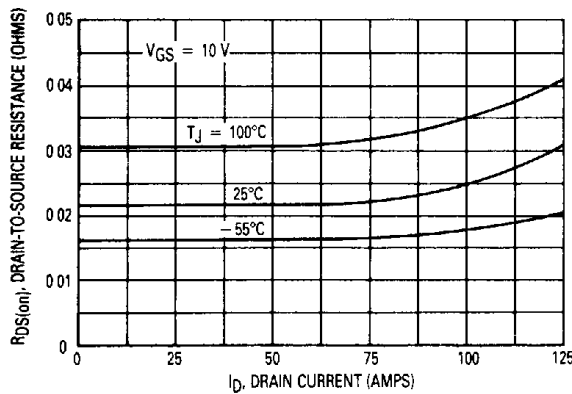

Figure 5. On-Resistance versus Drain Current

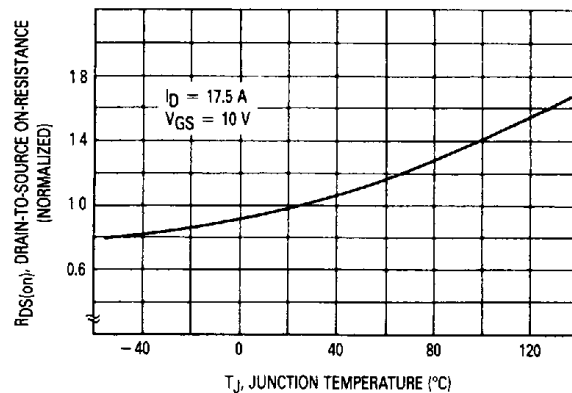

Figure 6. On-Resistance Variation With Temperature

SAFE OPERATING AREA INFORMATION

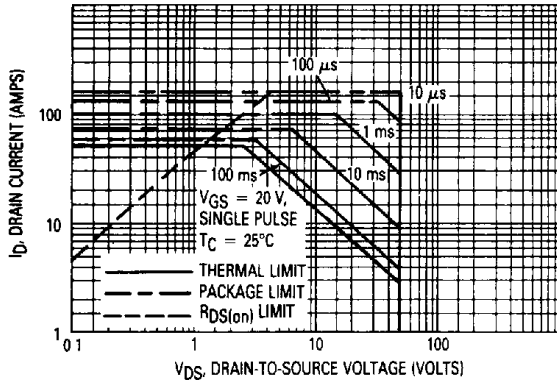

Figure 7. Maximum Rated Forward Biased Safe Operating Area

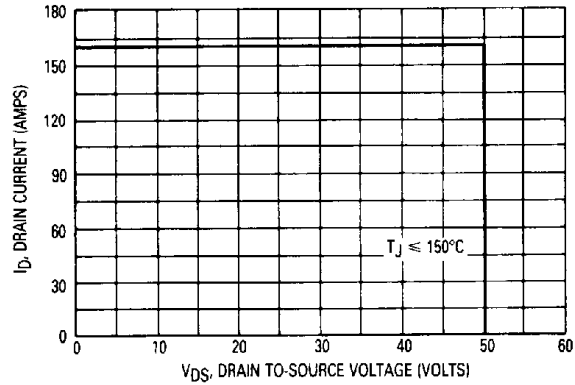

Figure 8. Maximum Rated Switching Safe Operating Area

3

FORWARD BIASED SAFE OPERATING AREA

The FBSOA curves define the maximum drain-to-source voltage and drain current that a device can safely handle when it is forward biased, or when it is on, or being turned on. Because these curves include the limitations of simultaneous high voltage and high current, up to the rating of the device, they are especially useful to designers of linear systems. The curves are based on a case temperature of 25°C and a maximum junction temperature of 150°C. Limitations for repetitive pulses at various case temperatures can be determined by using the thermal response curves. Motorola Application Note, AN569, "Transient Thermal Resistance-General Data and Its Use" provides detailed instructions.

SWITCHING SAFE OPERATING AREA

The switching safe operating area (SOA) of Figure 8 is the boundary that the load line may traverse without incurring damage to the MOSFET. The fundamental limits are the peak current, I_{DM} and the breakdown voltage, $V_{(BR)DSS}$. The switching SOA shown in Figure 8 is applicable for both turn-on and turn-off of the devices for switching times less than one microsecond.

The power averaged over a complete switching cycle must be less than:

$$\frac{T_{J(max)} - T_C}{R_{\theta JC}}$$

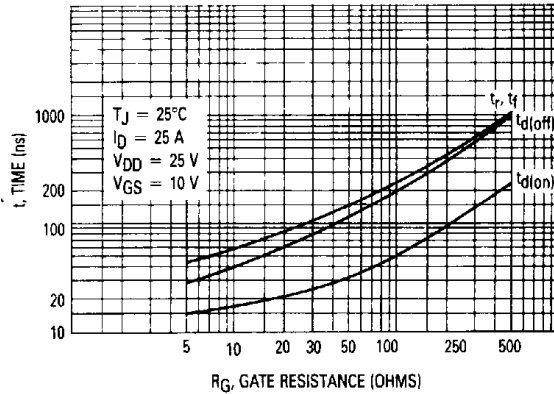

Figure 9. Resistive Switching Time Variation versus Gate Resistance

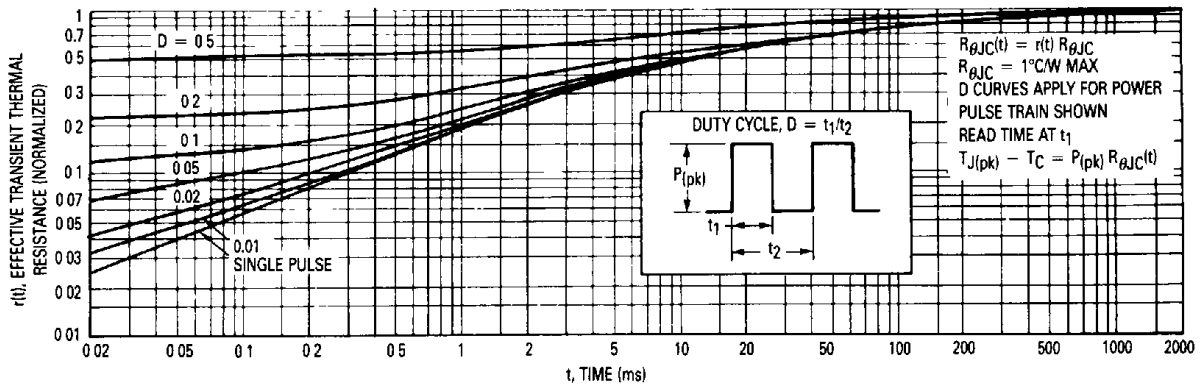

Figure 10. Thermal Response

COMMUTATING SAFE OPERATING AREA (CSOA)

The Commutating Safe Operating Area (CSOA) of Figure 12 defines the limits of safe operation for commutated source-drain current versus re-applied drain voltage when the source-drain diode has undergone forward bias. The curve shows the limitations of I_{FM} and peak V_{DS} for a given rate of change of source current. It is applicable when waveforms similar to those of Figure 11 are present. Full or half-bridge PWM DC motor controllers are common applications requiring CSOA data.

Device stresses increase with increasing rate of change of source current so di_s/dt is specified with a maximum value. Higher values of di_s/dt require an appropriate derating of I_{FM} , peak V_{DS} or both. Ultimately di_s/dt is limited primarily by device, package, and circuit impedances. Maximum device stress occurs during t_{rr} as the diode goes from conduction to reverse blocking.

$V_{DS(pk)}$ is the peak drain-to-source voltage that the device must sustain during commutation; I_{FM} is the maximum forward source-drain diode current just prior to the onset of commutation.

V_R is specified at 80% of $V_{(BR)DSS}$ to ensure that the CSOA stress is maximized as I_S decays from I_{RM} to zero.

R_{GS} should be minimized during commutation. T_J has only a second order effect on CSOA.

Stray inductances in Motorola's test circuit are assumed to be practical minimums. dV_{DS}/dt in excess of 10 V/ns was attained with di_s/dt of 400 A/ μ s.

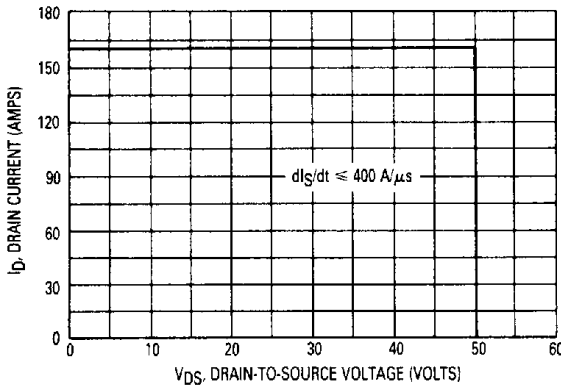

Figure 12. Commutating Safe Operating Area (CSOA)

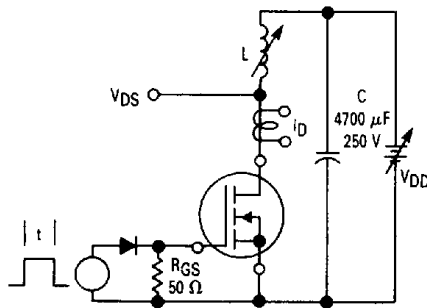

Figure 14. Unclamped Inductive Switching Test Circuit

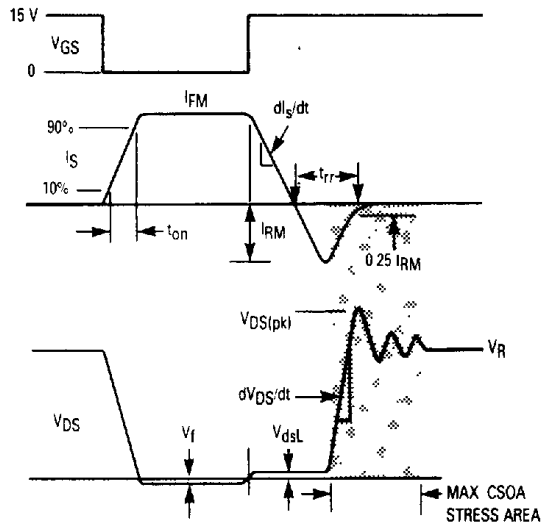

Figure 11. Commutating Waveforms

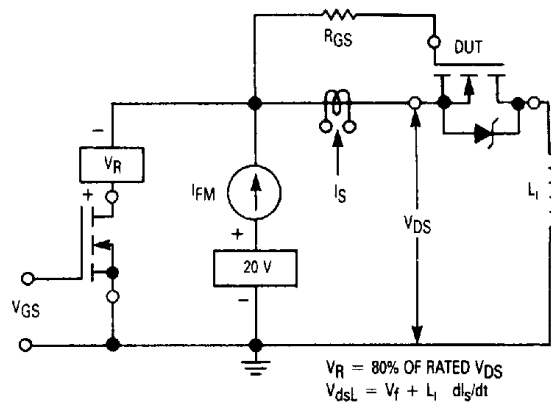

Figure 13. Commutating Safe Operating Area Test Circuit

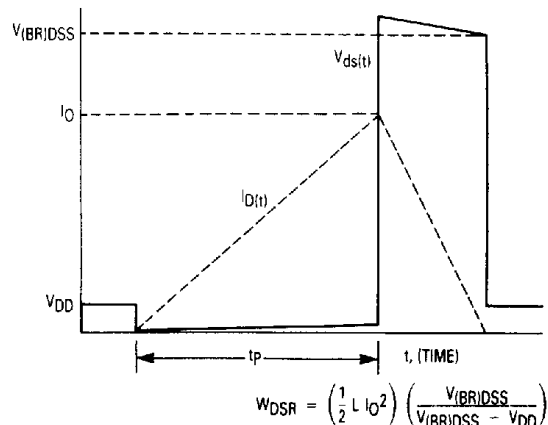

Figure 15. Unclamped Inductive Switching Waveforms

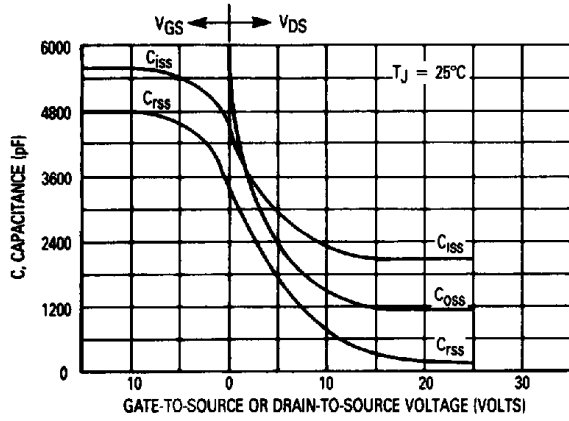

Figure 16. Capacitance Variation

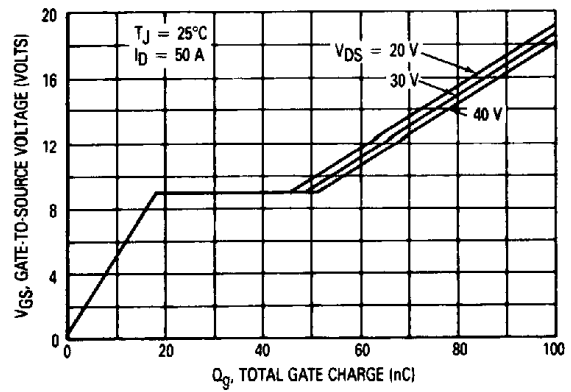

Figure 17. Gate Charge versus Gate-to-Source Voltage

3

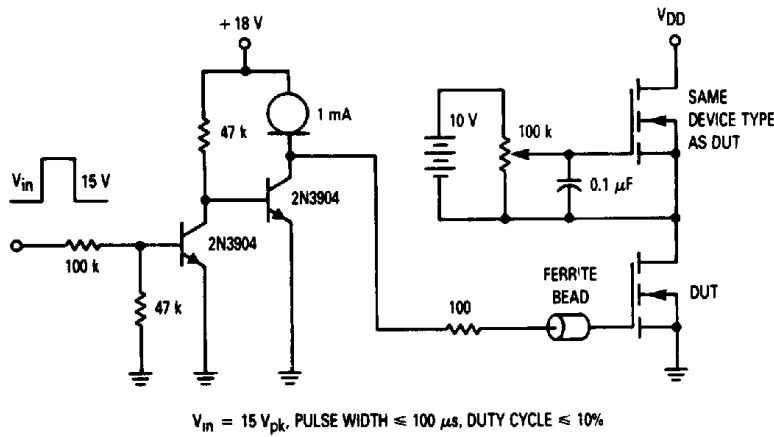

Figure 18. Gate Charge Test Circuit